

# BATTERY MEASURING TECHNOLOGY FOR AUTOMATION

PIONEERING TESTING CONCEPTS FOR MODERN BATTERY SYSTEMS



# BATTERY MEASURING TECHNOLOGY PIONEERING SOLUTIONS – MADE BY burster

## GLOBAL APPLICATIONS – ADVANCED IN ALL AREAS

With the global increase in the use of high-quality and safety-critical battery cells in areas of e-mobility, energy storage or mobile standardized power tools and many more, battery measuring technology is becoming increasingly important in industrial automation for suppliers, plant manufacturers and machine builders. Reliable and traceable recording, evaluation and analysis of quality-related electrical parameters is increasing continuously, also because of the tremendous cost increase. The battery measuring technology from burster supports you in the implementation of your high-quality requirements and the need for industrial networking of your production, installation and development processes using innovative measuring technology and state of the art communication and fieldbus connections. Securely equipped for the demanding measuring tasks of tomorrow.



E-MOBILITY



COMMUNICATION ELECTRONICS



TRANSPORT VEHICLES



INDUSTRIAL TRUCKS

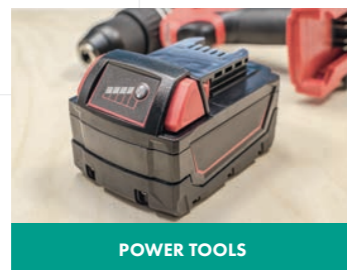

POWER TOOLS



AIR CONDITIONING AND  
ENERGY TECHNOLOGY

## HIGH PERFORMANCE – INDIVIDUAL CELLS, BATTERY MODULES AND SYSTEMS

- Battery testing → Voltage, frequency, internal resistance, temperature & capacity
- Battery diagnosis → Determination of charging condition, ageing condition and integrity
- Battery analysis → Referencing, modelling and trend recognition

## SIMPLE, COMPACT, FAST – FOCUS ON YOUR PROCESS

Regardless of whether you have one or many battery cells to measure, burster has smart and cost-effective solutions for many applications.



Research & Development



Storage

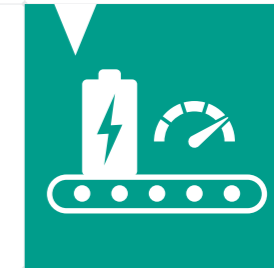

Begin/Middle of Line

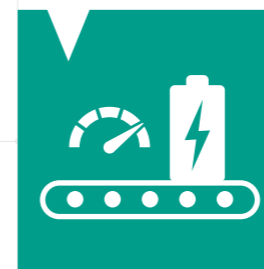

End of Line



Service



Second Life

## FLEXIBLE INTEGRATION

The importance of the increasing networking of man, machine and product is an essential characteristic of **Industry 4.0**. Production processes must be designed to be analysable, controllable and safe. Battery measuring technology from burster can be integrated in the controller or host environment via PROFINET or EtherNet and USB communication interfaces, for example.

# THE BASICS OF ELECTRIC BATTERY MEASURING TECHNOLOGY

Important battery parameters can be reliably and precisely recorded in a wide range of testing processes with the innovative single frequency or spectral impedance measuring procedure from burster. Basically, all impedance measuring systems operate with the four-conductor measuring method with 2 connections for power input and voltage measurement, so that supply cable and transitional resistances are eliminated.

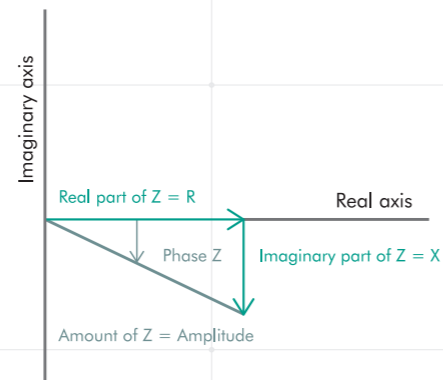
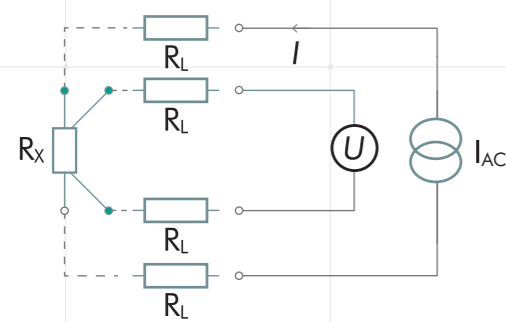

An alternating current  $I_{AC}$  is imposed in the test object and measures the resulting voltage drop  $U_{AC}$ . The AC voltage measurement takes place selectively and synchronously, with results in accordance with the real and imaginary part. The complex impedance (Z) is obtained by means of mathematical calculations. The real part represents the ohmic component, and the imaginary part represents the capacitive/inductive component.

## MEASURING PROCEDURE AND CHARACTERISTICS

burster provides several measuring procedures for the qualitative and safety-related determination of battery parameters. Schematic design and equivalent circuit:

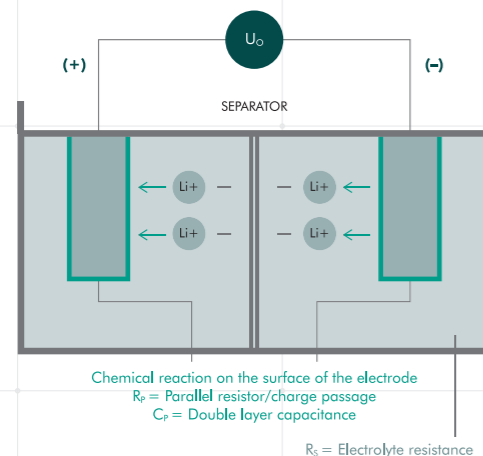

Principal illustration of a battery

CHARACTERISTICS	CONTEXT
$R_p$ = Parallel resistance	Resistance when charge transfer occurs, electrode quality
$C_p$ = CPE	Electrode quality, double layer capacity
$L_s$ = Serial inductance	Conductor inductance, battery geometry
$R_s$ = Series resistance	Electrolyte resistance
$U_0$ = Voltage	Open circuit voltage ( $U_{OC}$ )

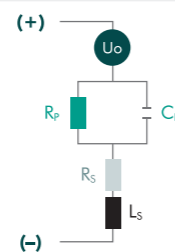

Characteristics and context from the simplified battery equivalent circuit

The internal resistance of a battery cell is very frequency-dependent. As the frequency increases, this reduces and has reactive components (capacitive/inductive). With the **individual or AC and DC internal measurement** with previously defined frequencies (typically 1 kHz and 10 Hz) significant battery parameters such as the **AC and DC resistance** and the **battery voltage** (SoC charge condition) and the **temperature** are measured and evaluated in just a few milliseconds.

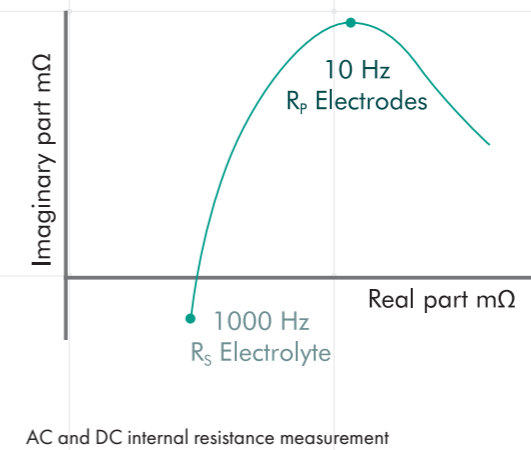

With the **spectral impedance measurement** (also known as Electric Impedance Spectroscopy (EIS)), the AC current resistance is determined as a function of the frequency of an AC voltage. The impedance trend (real and imaginary component) is depicted via periodic frequency pass-throughs in a locus curve. With this measuring procedure, you can **obtain qualitative statements about the resistance of the electrolytes, the type of electrode or the diffusion of a battery.**

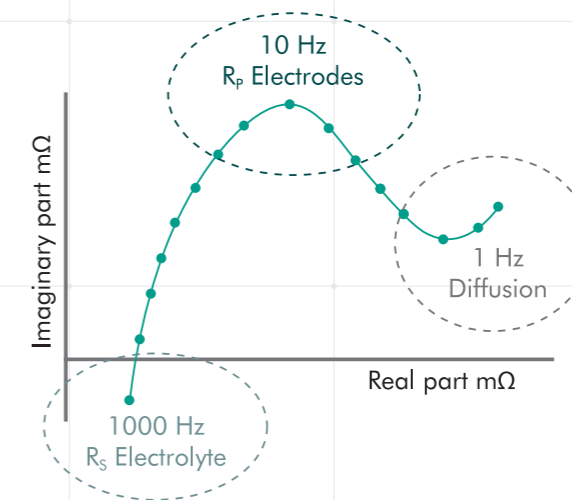

Spectral impedance measurement, result display in Nyquist diagram locus curve

Additional referencing and evaluation functions make comparison and evaluation of measurements possible with reference values such as spectral trends, model parameters or individual impedance values. Diagnosis tools make it possible to obtain a comprehensive evaluation of the battery characteristics (charge condition, ageing, capacity and others).

# FOCUS ON QUALITY COST-EFFECTIVENESS AND SAFETY FOR ALL AREAS

High-performance battery modules usually consist of many individual cells connected in parallel or series. Differences in the internal resistances lead to differentiated charging/discharging behaviour and can therefore have serious effects on operating behaviour, intrinsic heating and the associated ageing process.

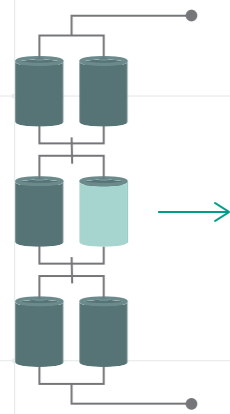

An increased internal resistance of a battery cell leads to more heating, which leads to acceleration of the ageing process and therefore faster reduction of the capacity. This reduces the service life of a battery.

## QUALITY ASSURANCE BY MEANS OF IDENTIFYING WEAKNESSES

In order to avoid this beforehand, an inspection is carried out at very early phases of the process (e.g. BoL) in order to obtain a general OK/NOK statement and also achieve an optimum match result.

**The weakest cell is decisive in a complex battery combination. The identification thereof is very important for the quality and functionality of the entire battery pack.**

As well as the open circuit voltage measurement, burster provides a very fast measuring technology for continuous manufacturing monitoring with the AC and DC internal resistance measuring procedure in order to achieve the best possible battery balancing.

## 100 % ROUND CELL TESTING: OPEN CIRCUIT VOLTAGE MEASUREMENT VS AC AND DC INTERNAL RESISTANCE MEASUREMENT

### OPEN CIRCUIT VOLTAGE MEASUREMENTS

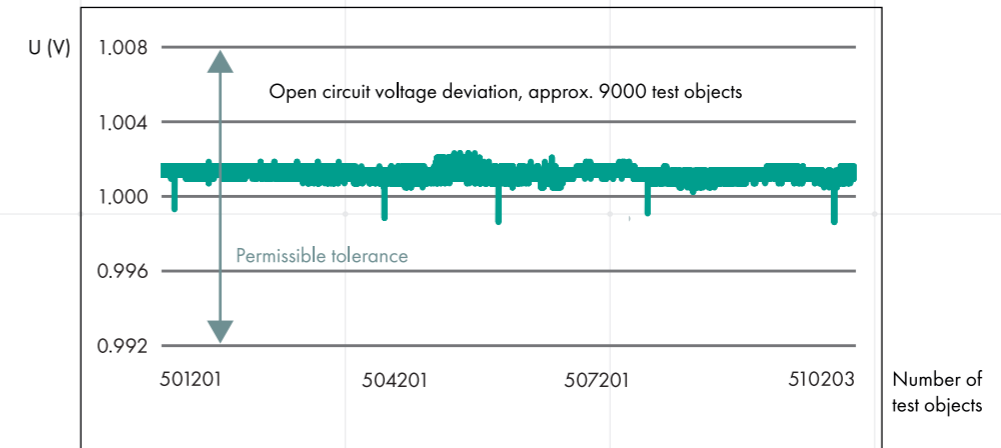

### AC AND DC INTERNAL RESISTANCE MEASUREMENT

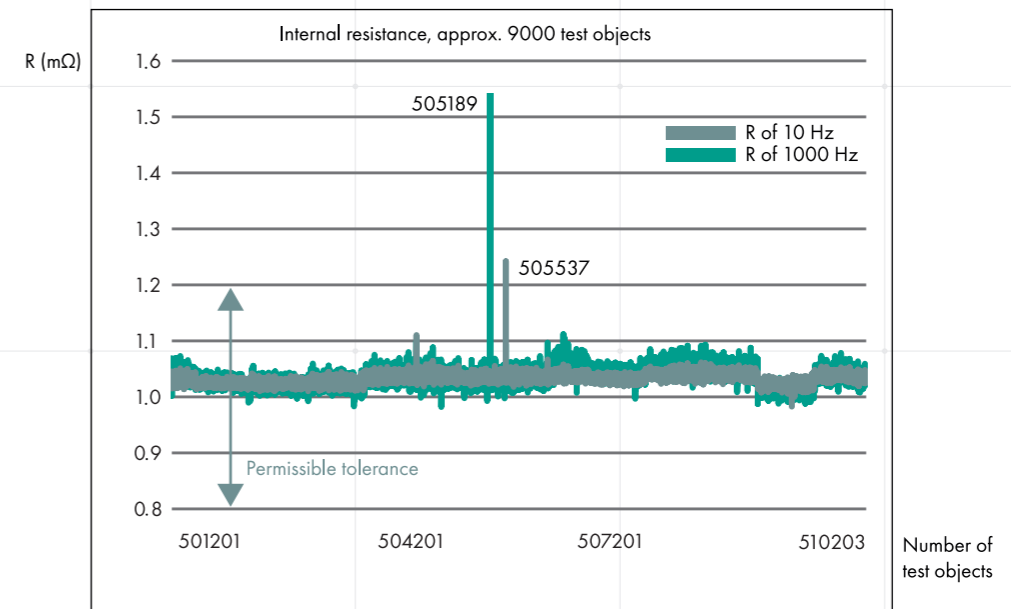

Outlier with major deviations, only both measurements provide information about the battery quality

# KEEPING AN EYE ON MEASUREMENT ACCURACY PRACTICAL RELEVANCE WITH COMPETENCE

burster battery measuring technology impresses with outstanding accuracy, long-term stability and ensures that the quality management is on the safe side. In addition to measurement technology specifications which influence the measuring accuracy of an impedance measurement, the ambient temperature, charge condition, cable routing, measuring environment and contacting play a major part with regard to the qualitative evaluation of the electrical characteristics.

Connecting cables laid in parallel can cause induction, large surfaces between the respective connecting cables lead to crosstalk and metallic overlays or underlays can also generate eddy currents and therefore affect the measuring result. Optimum cable routing and an optimum measuring situation take the following into consideration:

- Small surface between the respective U/I cables
- Twisting of the respective current and voltage cables as far as just before the test object
- No metallic underlays

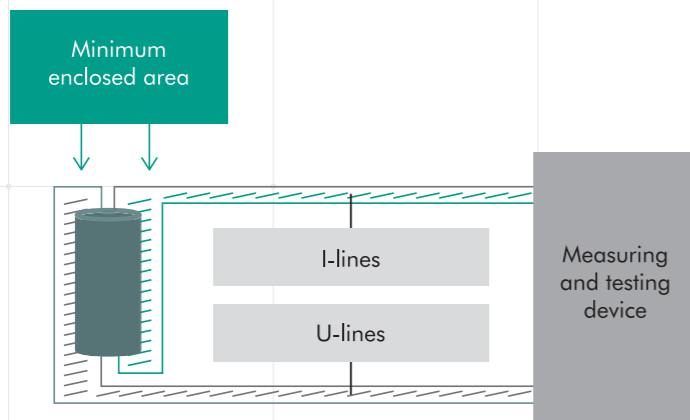

Inaccurate test object contacting, variable press-on force or geometry/surface/material of the contact pins also have a decisive part to play with regard to reproducible measuring results.

- Test object contacting of the pairs of measuring cables separate and from different sides
- Reproducible press-on force and positions

burster supports you in a competent and reliable way with application issues regarding the subject of measuring quality.

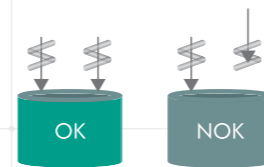

burster measuring devices with contact error detection

# AT A GLANCE MEASURED QUANTITIES FOR BATTERY TECHNOLOGY

## MEASURING, EVALUATING, ANALYSING

<b>Electrical, thermal parameters</b>	Impedance	Battery cell
	AC/DC resistance	Battery cell
	Voltage	Battery cell, battery pack and battery module
	Temperature	Battery cell, BMS, battery pack and battery module
	Capacity	Capacity test, indirect charge capability measurement on battery cells
<b>Other electrical parameters</b>	Insulation resistance	Battery combination, safety check, chassis
	DC resistance	Contact resistance, path resistance
<b>Mechanical parameters</b>	Force	Welding process press-on force measurement, stress test measurement in the module, impact resistance
	Displacement	Expansion measurement after module charging and discharging cycles
	Torque	Torque determination during chassis installation

COMPACT  
FAST  
AC DC  
BUS-CAPABLE  
5-CHANNEL

## BATTERY MEASURING MODULE 2511 HIGH-SPEED FOR SERIES PRODUCTION

The All-in-One module 2511 is predestined for use in automated manufacturing testing of high-performance battery modules and battery packs, regardless of whether they are round, prismatic or pouch cells. In single or multichannel mode, important battery parameters such as AC and DC internal resistance or cell voltage can be recorded and evaluated extremely fast and precisely using fieldbus-capable technology in order to make quality-relevant statements regarding ageing (electrolyte, electrode quality) or charge condition.

### HIGHLIGHTS

- AC and DC internal resistance measurement in one device
- High-speed measuring and evaluation mode in a few milliseconds
- Measurement of 1 to 5 individual cells
- Different housing and mounting concepts in compact IP54 version
- Excellent price/performance ratio
- Easy integration into process control via PROFINET

### FEATURES

- Impedance measurement at 1 kHz, optionally also at 1 Hz, 10 Hz, 100 Hz possible
- Four-conductor measuring method for maximum precision
- Resistance measuring range of 0 ... 10 mΩ, 0 ... 30 mΩ and 0 ... 100 mΩ
- Open circuit and module voltage measurement of 0 ... 5 VDC/0 ... 60 VDC
- Temperature measurement –40 ... 80 °C
- Different operating modes/measurement parameters selectable
- PC software for intuitive parametrisation and configuration via EtherNet/USB

### APPLICATION AREAS

- Excellent for technology-independent test object formats such as 18650, 21700 or 26650
- 100% testing in series production of industrial high-performance battery modules, battery cells such as large-scale storage, power tools, communication electronics or partially and fully electrified mobility vehicles, fork lift trucks and much more



# HIGH-VOLTAGE BATTERY CONTROLLER 2550 KEEPING AN EYE ON UNIVERSAL QUALITY

The compact, universal battery controller is one of the world's first devices for measuring the **spectral impedance** of low and **high voltage** battery systems. Irrespective of the technology, batteries or accumulators can be tested in a reliable, fast and safe way.

## HIGHLIGHTS

- Individual frequency and spectral impedance measurement for result mapping in a locus curve (real and imaginary component)
- High-voltage measurement up to 900 VDC
- Diagnosis function for ageing and charge condition
- Evaluation mode for target/actual comparisons of batteries
- Determination of model parameters  $R_s$ ,  $R_p$ ,  $C_p$

## FEATURES

- Voltage measurement of 0 ... 100 VDC to 0 ... 900 VDC
- AC resistance range (impedance) 0 ... 1 m $\Omega$  and 0 ... 100 m $\Omega$
- Resistance measuring range of 0 ... 1 m $\Omega$  and 0 ... 3 m $\Omega$
- Frequency range 1 Hz ... 1 kHz

## APPLICATION AREAS

- Suitable for almost all technology-independent test object formats such as 18650, 21700 or 26650
- Predestined for troubleshooting in development/laboratories or the manufacture of individual cells, on-board power supply batteries and high-voltage batteries
- Analysis of operating behaviour in the test phase & rapid diagnostics in the support area



# BATTERY TESTER 2560 SAFETY – COMPACT AND FLEXIBLE

The extremely compact flexible battery tester model 2560 is a measuring device which is attractively priced and can be operated intuitively via PC software. Precise battery cells with different geometries can be tested, analysed and evaluated in the development area and the laboratory using the four-conductor measuring procedure.

## HIGHLIGHTS

- Determination of the internal resistance using intrinsic frequency and spectral impedance measurement
- Result depiction in a locus curve (real and imaginary component)
- Capacity test using partial or full discharge measurement
- Determination of various model parameters for validating electrolyte and electrode quality

## FEATURES

- Voltage measurement of 0 ... 5 VDC to 0 ... 60 VDC
- Resistance range (real and imaginary component) of 0 ... 1 m $\Omega$  to 0 ... 1  $\Omega$
- Frequency range of 0.1 Hz ... 1 kHz, logarithmically adjustable
- Capacity measurement of 25 mAh ... 10 Ah
- Temperature measurement of 0 ... 60 °C

## AREAS OF APPLICATION

- For analysing and testing round, prismatic and pouch cells
- Excellent for troubleshooting in the development area/laboratory or the manufacturing area
- Rapid diagnostics in the support area and analysis of operating behaviour in the test phase



# THE WHOLE WORLD OF MEASURING TECHNOLOGY FOR BATTERY PRODUCTION AND TESTING

KNOW-HOW FROM A SINGLE SOURCE

## RESISTOMAT® 2311 INNOVATIVE RESISTANCE MEASURING TECHNOLOGY

The new RESISTOMAT® 2311 has been designed and optimised for very fast applications in automation. High performance, combined with innovative functional features and exceptional precision, make it ideal for a wide range of tasks in peripheral areas of industrial battery module manufacturing, where 100 % process monitoring with real-time data transfer to higher-level controllers is required.

### HIGHLIGHTS

- Extremely fast measurement, including evaluation  $\leq 10$  ms
- Extremely high measuring accuracy 0.03 % F.S.
- Real time fieldbus data transmission
- 32 measuring programs for a wide range of parts

### FEATURES

- Measuring ranges of 0 ... 20 m $\Omega$  to 200 k $\Omega$
- Thermoelectric voltage compensation and dry circuit measurement in accordance with DIN IEC 512
- Temperature compensation for all materials
- Process implementation via PROFINET, I/O interface, fast and reliable

### AREAS OF APPLICATION

- Determination of contact resistances in battery pack production
- Checking of laser welding connections on contact lugs
- Resistance measurements on busbars for reducing power loss

## RESISTOMAT® 2411 HIGH-CAPACITANCE MEASURING TECHNOLOGY FOR PRODUCTION

The modern RESISTOMAT® 2411 is a universal resistance measuring device for precise and fast measurement of high-capacitance resistors for a wide range of industrial usage areas. Practical device functions in combination with extraordinary performance features make it ideal for many tasks in pre-series and also series production-accompanying testing of industrial battery manufacturing, in which high qualitative standards have to be ensured by means of comprehensive monitoring, and the result data has to be transmitted to a control platform via PROFINET.

### HIGHLIGHTS

- Extremely short measuring times
- Extremely high measuring accuracy from 0.05 % F.S.
- Real time fieldbus data transmission
- Various OK/NOK evaluation functions

### FEATURES

- Measuring ranges of 0 ... 100 m $\Omega$  to 100 G $\Omega$
- Test voltage 0 ... 1000 VDC
- Cable break detection
- Automatic and manual measuring range changeover
- Process implementation via PROFINET, I/O interface, fast and reliable

### AREAS OF APPLICATION

- Determination of insulation resistances in battery pack manufacturing
- Insulation measurement on neighbouring battery pack modules
- High-capacitance safety measurement of isolated busbars

RESISTOMAT® 2311



PROFI  
NET

RESISTOMAT® 2411



PROFI  
NET



## DIGIFORCE® 9307, 9311 INTELLIGENT HIGH-END TECHNOLOGY

DIGIFORCE® monitors and analyses processes in which precisely defined functional relationships need to be proven between two or more measured quantities of the process. Recording, visualisation and evaluation of the X/Y trend make continuous process control possible and also a very detailed analysis of series production-accompanying tests or development examinations.

### HIGHLIGHTS

- Monitoring of up to two synchronous processes
- Up to 128 measurement programs for high part relevance
- Intelligent signal scanning by means of combination of  $\Delta t$ ,  $\Delta X$ ,  $\Delta Y$
- Extremely fast evaluation (15 ms) and data logging of dynamic measurements

### FEATURES

- Continuous diagnosis and analysis via innovative evaluation elements – window/trapezium/threshold/envelope/mathematical operations
- Interface for DMS/potentiometer/resistance/analogue process signal/incremental/EnDat/SSI
- Process implementation via PROFINET, Profibus, EtherCAT, EtherNet/IP, I/O interface, quick and reliable
- USB service interface on front

### APPLICATION AREAS

- Monitoring of crimp connections and solder-free press-fit contacts with live contact elements
- Setting control of vehicle wiring harness clips
- Mechanical stress test of lithium ion batteries (measurement of force/displacement/open circuit voltage)
- Process monitoring when pressing plastic elements into the battery chassis for ensuring tightness
- Monitoring of press-on force with contact welding connections



## INSTRUMENTATION AMPLIFIER 9250 FIELDBUS CONTROLLER 9251 PERFECT NETWORKING FOR INDUSTRY 4.0

Contemporary automation solutions require networking capability, speed, accuracy, integration capability and cost-effectiveness of their metronomic components. The new industrial EtherNet-capable measuring amplifier generation including fieldbus controller with high precision, multi-channel capability, automatic sensor detection, flash configuration and much more provide all of this.

### HIGHLIGHTS

- Fast commissioning by means of flash configuration
- Linearity deviation  $< 0.005\%$  F.S.
- Strain gage full bridges, voltage measurement, potentiometers, TTL inputs
- Fast measuring speed
- Multi-channel capability
- Can be integrated in PROFINET, EtherCAT and EtherNet/IP fieldbus systems
- Automatic measuring channel detection
- Fieldbus data transfer with real-time capability

### APPLICATION AREAS

- Checking of laser welding connections on contact lugs
- Multi-channel open circuit voltage measurement of battery cells



# PRECISION FORCE, TORQUE, DISPLACEMENT AND PRESSURE SENSORS

## STANDARD AND CUSTOMER-SPECIFIC SENSOR SOLUTIONS

As one of the leading manufacturers of **force, torque, pressure and displacement sensors**, we provide you with pioneering ideas, consultancy know-how and smart solutions in all production and quality assurance processes. As well as innovative and proven standard products from miniature to large-scale versions, we also develop and manufacture **made-to-measure sensor solutions** for completely individual measuring tasks.

### FORCE SENSORS

- Measuring ranges 0 ... 2.5 N to 0 ... 2 MN
- Linearity deviations up to  $< \pm 0.03$  % F.S.
- Compact, robust, user-friendly installation



### TORQUE SENSORS

- Measuring ranges 0 ... 0.005 N·m to 0 ... 5000 N·m
- Maximum precision for static and rotating applications
- Different mechanical adaptations



### DISPLACEMENT SENSORS

- Measuring ranges from 0 ... 1 mm to 0 ... 2000 mm
- Measuring accuracy of up to  $\pm 0.5$   $\mu$ m
- Output 0 ... 5/10 VDC, 4 ... 20 mA, USB and TTL

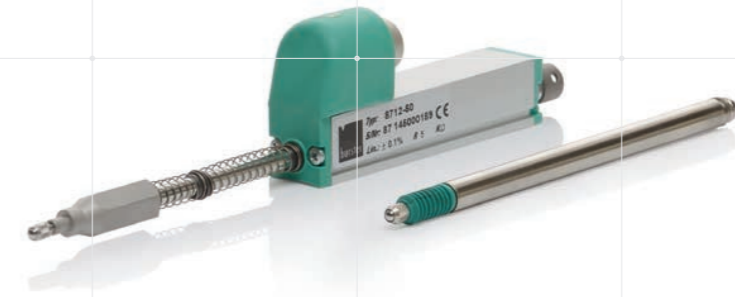

### PRESSURE SENSORS

- Measuring ranges 0 ... 35 mbar to 0 ... 5000 bar
- Output 0 ... 5/10 VDC, 4 ... 20 mA, USB
- Measuring accuracy  $< \pm 0.1$  % F.S.



### WIDE RANGE OF OPTIONS

such as increased temperature deployment ranges, overload protection, dual range version, higher protection class, **customer-specific versions**, extend the range of usage options.

### APPLICATION AREAS

- Press-on force monitoring in the laser welding process of cell poles
- Long-term examinations of lithium battery packs with regard to expansion
- Torque monitoring in battery module manufacturing

# APPLICATIONS AND USES

## IMPRESSIVE POWER

### 16-CHANNEL HIGH-SPEED APPLICATION – 100 % MONITORING IN VEHICLE BATTERY MODULE RECEIVED GOODS CHECKING

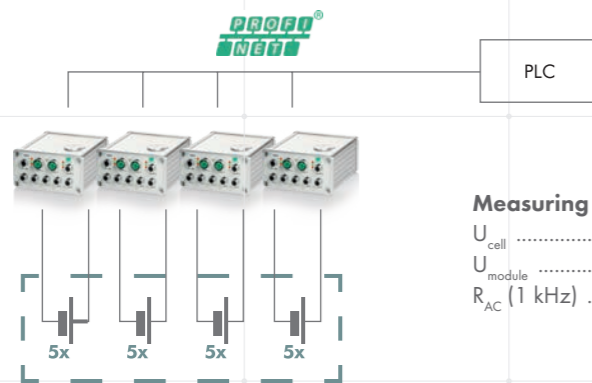

#### Measuring and evaluation parameters

$U_{cell}$  .....  $\approx 0 \dots 3.4$  to  $3.7$  VDC  
 $U_{module}$  .....  $\approx 54.4 \dots 59.2$  VDC  
 $R_{AC}$  (1 kHz) .....  $\approx 0 \dots 0.85$  m $\Omega$

Many battery cells are required to manufacture and install high-performance battery modules for electrically operated vehicles. In received goods checking area, important battery parameters of each individual cell must be reliably measured and evaluated within very short cycle times.

After contacting the prismatic cells, the internal resistance with 1 kHz and the cell and module voltage of all 16 cells are measured and evaluated within approx. 1.6 s with the cascaded battery measuring module and transferred to a PLC in real time.

### 5 CHANNEL APPLICATION MATCHING OF BATTERY CELLS FOR LARGE-SCALE STORAGE

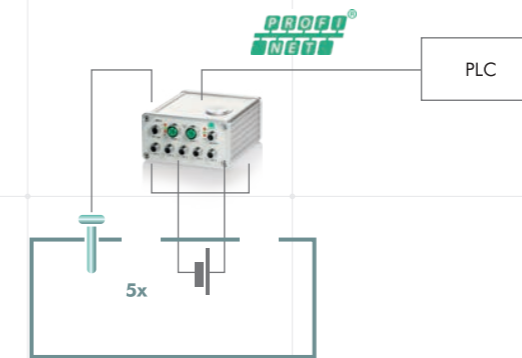

#### Measuring and evaluation parameters

$U_{cell}$  .....  $\approx 0 \dots 3.3$  to  $3.8$  VDC  
 $U_{module}$  .....  $\approx 16.5 \dots 19$  VDC  
 $R_{AC}$  (1 kHz) .....  $\approx 0 \dots 0.95$  m $\Omega$   
 $R_{DC}$  (10 Hz) .....  $\approx 1.75$  m $\Omega$   
 $\vartheta$  .....  $\approx 22 \dots 28$  °C

Many round cells are often used in battery operated large-scale storage systems. Before these are installed, different battery parameters of each individual cell must be exactly and quickly measured and evaluated in order to achieve qualitative matching. The contacting of the round cells takes place using the four-conductor measuring method (for each current and voltage cable). The two-frequency impedance measurement is used to determine the series resistance (electrolyte) and the parallel resistance (electrodes). In parallel to this, the respective cell voltage and temperature are recorded and evaluated. At the control side, the data is passed over via PROFINET. All measuring and evaluation data is archived for traceability.

### 1 CHANNEL APPLICATION FOR QUICK TESTING OF BATTERY CELLS

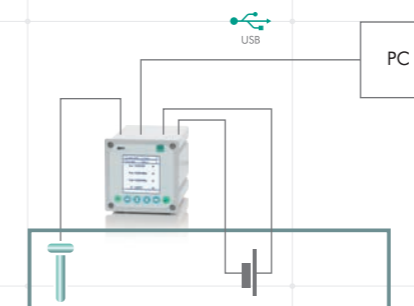

#### Measuring and evaluation parameters

$U_{cell}$  .....  $\approx 0 \dots 18.2$  to  $18.8$  VDC  
 $R_{AC}$  (1 kHz) .....  $\approx 0 \dots 8.80$  m $\Omega$   
 $R_{DC}$  (10 Hz) .....  $\approx 0 \dots 3.12$  m $\Omega$   
 $\vartheta$  .....  $\approx 20 \dots 29$  °C

Battery cells with a relatively high internal resistance can generate more heat; chemical processes can accelerate the capacitance reduction and the internal resistance increases. The resistance can change due to transport or handling movements. In order to ensure that there is consistent quality in the assembly of power tools and the integration of the batteries, test objects are taken at random at individual workplaces and subjected to a quick test with regard to impedance and temperature behaviour, including a cell voltage measurement.

## ANALYSIS OF 48 V ON-BOARD POWER SUPPLY BATTERY

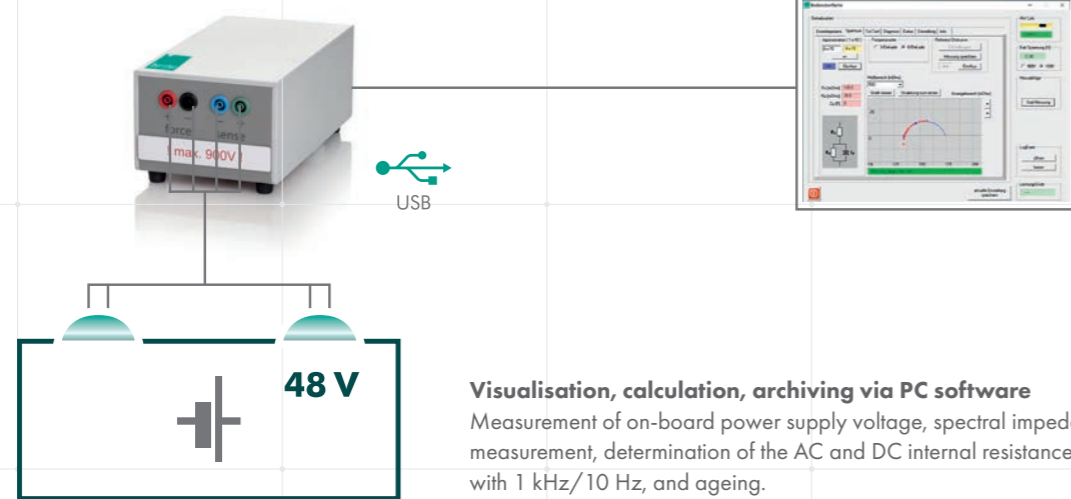

The open circuit voltage and the complex internal resistance between 1 Hz and 1 kHz must be determined on a 48 Volt on-board power supply battery, from which the status variables of ageing, charge condition and AC and DC internal resistance are to be mapped. Capacitive residual components can be determined without complicated discharge measurements in this way.

## DEVELOPMENT-SIDE QUALIFICATION TESTS ON BATTERIES FOR DETERMINING SUITABILITY

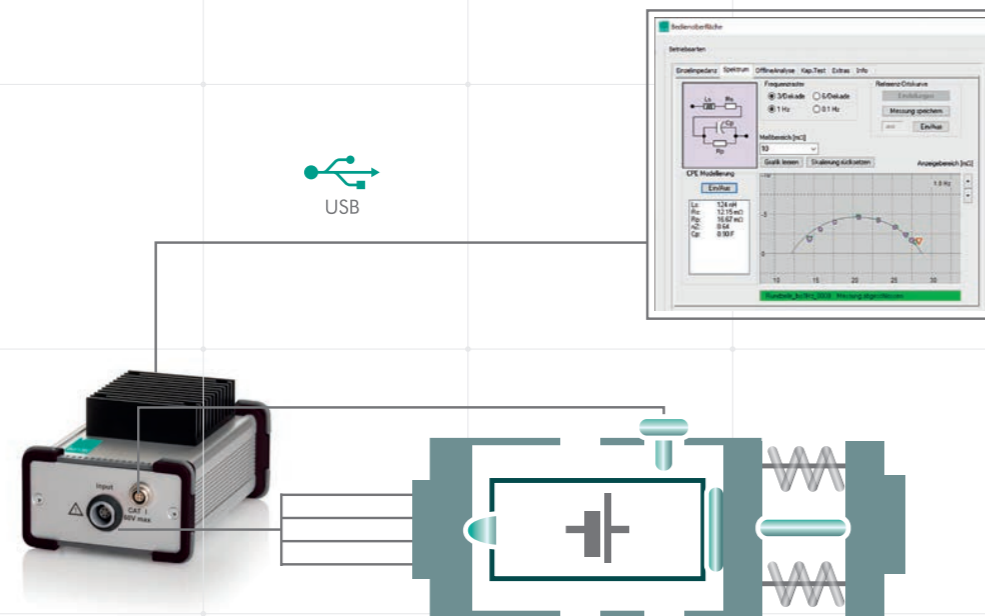

The battery quality of round cells must be determined on sample parts with the aid of the capacity, voltage and internal resistance parameters. The primary cell is fully charged for determining the capacity. The discharging of the cell takes place using a selectable constant current as far as the discharge limit voltage by the battery tester.

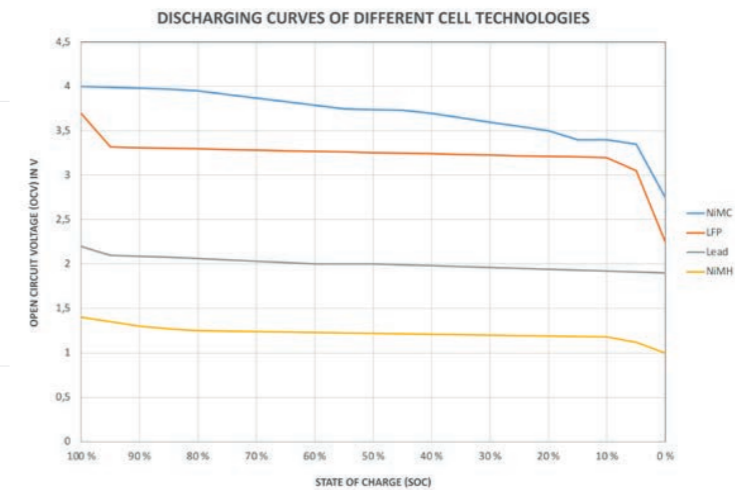

The frequency-dependent internal resistance of a cell contains real and imaginary components, and is displayed as a Nyquist plot via the spectral impedance measurement within the frequency range of 0.1 Hz to 1 kHz. Electrochemical characteristics can be assigned from this and checking for possible fluctuations during manufacturing can take place. Important model parameters such as series resistance ( $R_s$ , electrolyte statement), parallel resistance ( $R_p$ , electrode characteristic) and capacity ( $C_p$ , double layer capacity) can be calculated.

## RESISTANCE MEASUREMENT AT CONTACT LUGS

Very high-quality of spot-welded contact lugs is elementary in industrial battery pack or module production. The adherence to important mechanical parameters and also electrical parameters such as extremely **low contact resistances** are extremely important for ensuring the performance of a battery pack or an entire module. With the aid of the **RESISTOMAT® 2311**, precisely these spot welded connections are reliably recorded in the **low capacitance range**, evaluated within a very short time and transmitted to the control unit via **PROFINET**.

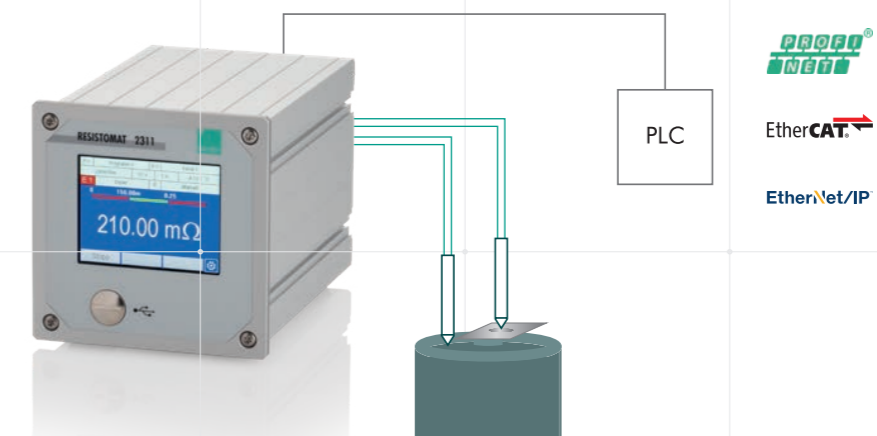

### PRESS-IN MONITORING DURING BATTERY MANUFACTURING

During the production of vehicle batteries, force/displacement monitoring of the insertion of the individual cell plates/cell blocks into the cell housing takes place. In order to optimise the cycle time, three units are always joined at the same time, whereby the joining force of each individual plate is recorded and evaluated. Recording and validation take place in the DIGIFORCE® 9307 X/Y process controller. Process results are available to both the station controller and the host to be logged via PROFINET and EtherNet UDP.

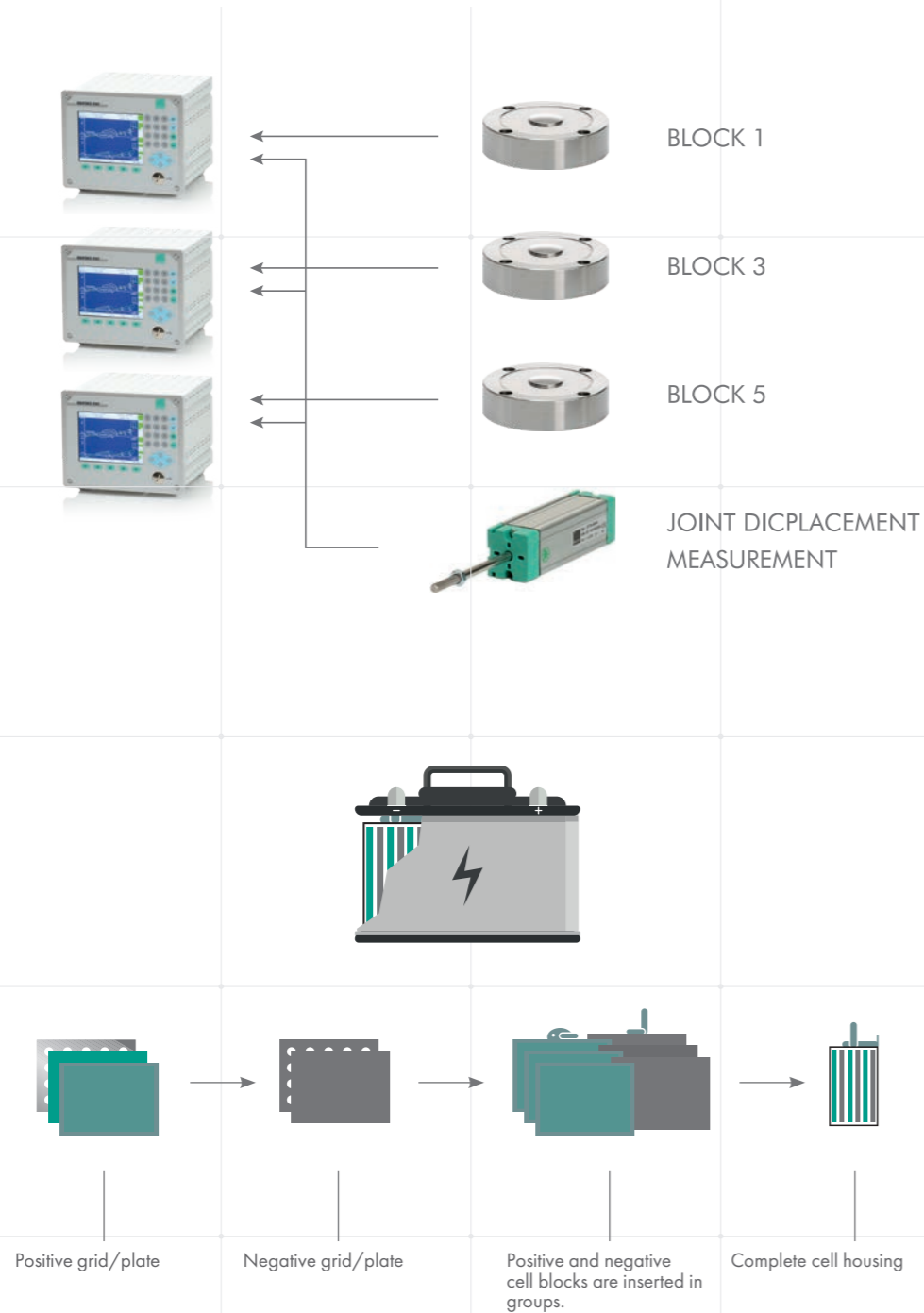

### FORCE MEASUREMENT AND MEASUREMENT TRANSMISSION DURING THE WELDING OF BATTERY CELLS

The poles of individual cells are welded in a vehicle battery assembly system. The poles of the up to 64 cells are connected with electrically conducting busbars using a laser welding procedure. In addition to a high degree of positioning accuracy a defined press-on force during the process must be 100 % guaranteed. In order to reduce the testing and cycle times, a force measurement is carried out at 8 poles in each case within the range of 400 to 500 N simultaneously. Measured value transmission takes place via 8 cascaded bus-capable instrumentation amplifier series 9250 and a PROFINET fieldbus controller model 9251 to a central control unit in real time.

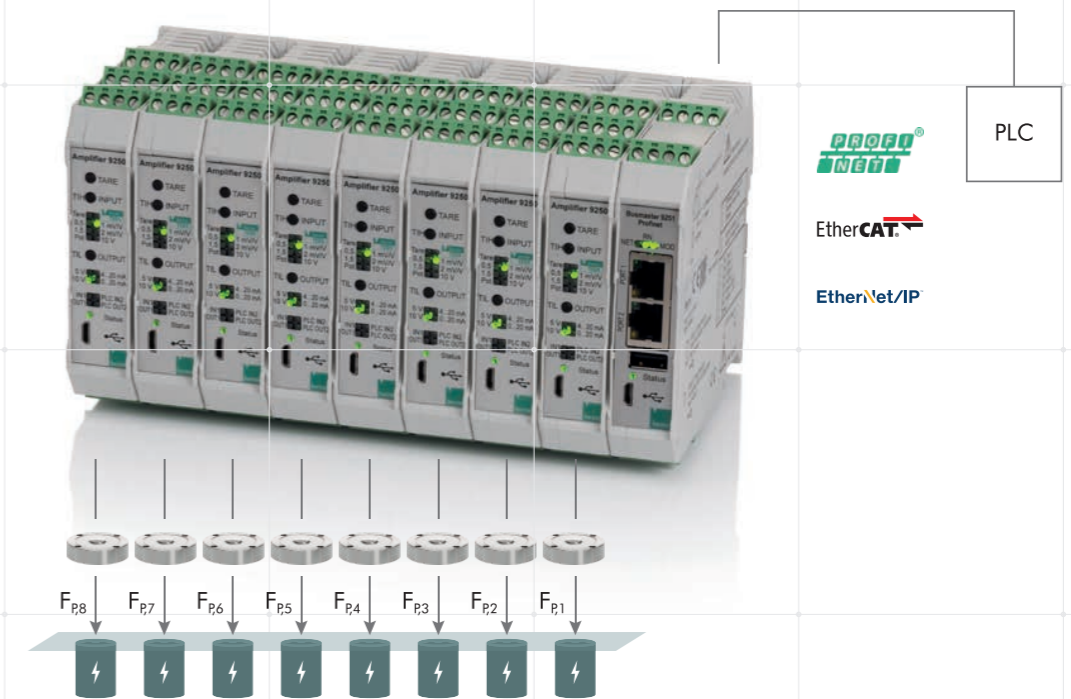

# DigiControl UNIVERSAL PC SOFTWARE PLATFORM FOR AUTOMATION – ONE FOR ALL

The burster automation controller and measuring devices such as the battery measuring module 2511, the new generation RESISTOMAT® and process controller series DIGIFORCE® support powerful and real-time capable fieldbus interfaces such as PROFINET. In this way, you make modern Industry 4.0 automation solutions possible. In order to increase process knowledge and therefore process reliability, you will benefit from a platform for device configuration, data backups, diagnoses and much more with the DigiControl PC software – for all burster systems.

## HIGHLIGHTS

- Convenient device configuration via Ethernet or USB interface
- Data backups (upload/download)
- Diagnosis including status of the PLC control signals
- Service functions such as device software update and remote control via the remote interface
- Laboratory operation for evaluation and analysis of the measurements, such as Excel data export of the 2511 measurement series with battery open voltage, internal resistance  $R_{AC}$ ,  $R_{DC}$  and module temperature. Visualisation, printing and export of the spectral impedance curve of the 2560 battery tester

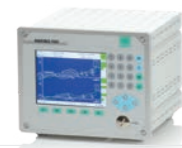

**DIGIFORCE®**  
process monitoring



**MEASURING MODULE 2511**  
battery measuring technology



**RESISTOMAT®**  
resistance measuring technology

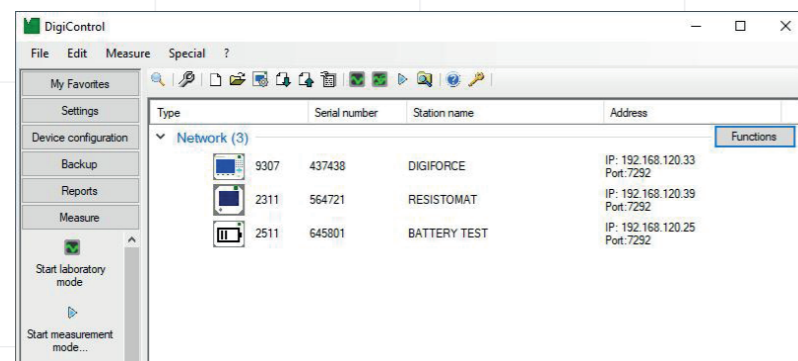

**DEVICE CONFIGURATION, BACKUP (UPLOAD/DOWNLOAD), DIAGNOSIS,  
SET-UP/LABORATORY OPERATION, MEASURING DATA LOGGING**

# SERVICE & SERVICES WE ARE THERE FOR YOU

We are convinced that a complete metrological solution also includes a high-quality range of services. For this reason, burster also offers a comprehensive range of battery measuring technology service packages. Modular components for planning, implementation and operation cover all of the relevant aspects of your task.

## CUSTOMER ADVICE/APPLICATION CONSULTANCY

The metrological requirements with regard to the testing/evaluation/analysis of high-quality industrially manufactured battery cells have many aspects. Experienced engineers and technicians are available to you with in-depth application advice, technical knowledge and an integrated view of the process chain, including metrological problem analysis and optimisation advice. We would be pleased to support you with a wide range of training and testing services, in order to familiarise you with measuring procedures, options and important application criteria.

## AFTER-SALES SUPPORT AND ON-SITE SERVICE

Our experts in the service team will deal with your concern quickly and professionally. Regardless of whether it is repairs, questions concerning measuring technology or re-calibration, we would be pleased to provide our expertise worldwide. Our on-site service engineers will provide support with maintenance, training, commissioning and re-calibration in accordance with your needs and requirements.

## CALIBRATION SERVICES

burster has one of the best accredited calibration laboratories in Germany with certification for mechanical and electrical parameters according to ISO 17025 by the Deutsche Akkreditierungsstelle. Thanks to our accreditation, your calibration will fulfil the highest demands with regard to accuracy, traceability and international comparability.

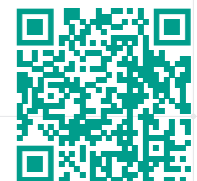

We would be pleased to support you with your calibration tasks, be it in-house or on site in the implementation of the IATF requirements.





**burster praezisionsmesstechnik gmbh & co kg**

Talstraße 1–5  
76593 Gernsbach  
Phone: +49 7224 645-0  
info@burster.com

[www.burster.com](http://www.burster.com)